

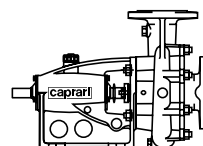

Single-stage Pumps
with Horizontal Shaft
*Pompes Mono-etagées
à Axe Horizontal*
**Pompe Monostadio
ad Asse Orizzontale**

caprari
pumping power



MEC-A

MEC-A

caprari

pumping power

The MEC-A series are single-stage centrifugal pumps, horizontal shaft, single-suction, fitted with a heavy duty pedestal which gives to the machine the high rigidity necessary for coupling it to combustion engines. The extended model range of these pumps, the possibility of direct coupling to electric motors or to combustion engines, the availability of special constructions enable to offer, for each different application, the best solution for reliability, efficiency and energy saving.

Les MEC-A sont des pompes centrifuges monocellulaires à axe horizontal, à aspiration axiale, montées sur chaise-palier largement dimensionné, assurant la rigidité indispensable pour l'accouplement aux moteurs à combustion interne.

L'étendue de la gamme de production de ces pompes, la possibilité de les accoupler directement à des moteurs électriques et à combustion interne, la disponibilité de constructions spéciales permettent de proposer pour toute utilisation différente la meilleure solution en tant que fiabilité, rendement et économie d'énergie.

Le MEC-A sono pompe centrifughe monostadio ad asse orizzontale, a semplice aspirazione, dotate di un supporto a sedia ampiamente dimensionato che assicura una grande rigidità alla macchina, indispensabile per l'accoppiamento ai motori termici. L'estensione della gamma di produzione di queste pompe, la possibilità di accoppiamento diretto a motori elettrici e a motori termici, la disponibilità di esecuzioni speciali permettono di proporre, per ogni diverso utilizzo, la soluzione ottimale dal punto di vista dell'affidabilità, del rendimento e, conseguentemente, dell'economia di esercizio.



CERTIFICATION FOR USE WITH DRINKING WATER: DM174, WRAS, ACS
CERTIFICATION POUR L'EMPLOI EN EAU POTABLE: DM174, WRAS, ACS
CERTIFICAZIONE PER L'IMPIEGO IN ACQUA POTABILE: DM174, WRAS, ACS

APPLICATIONS
APPLICATIONS
APPLICAZIONI

aqueducts

adduction d'eau

acquedottistica

water supply

alimentation d'eau potable

alimentazione idrica ad uso civile

conditioning

conditionnement

condizionamento

industrial applications

installations industrielles

applicazioni industriali

fire-fighting

lutte anti-incendie

antincendio

leisure parks

équipements pour les loisirs

impianti per il tempo libero

irrigation

irrigation

irrigazione

Electric pumping set - fixed installation
Groupe électropompe sur châssis pour installation fixe
Gruppo elettropompa su base per installazione fissa



☑ Machines conform to Directive 2009/125/EC (EcoDesign - ErP).

Machines conformes à la Directive 2009/125/CE (EcoDesign - ErP).

Macchine conformi alla Direttiva 2009/125/CE (EcoDesign - ErP).

☑ Pump casing volute type with top directed radially positioned flanged delivery outlet: installation flexibility.

Corps de pompe du type a volute avec tubulure de refoulement à bride, placé en position radiale et orienté normalement vers le haut : flexibilité d'installation.

Corpo pompa del tipo a voluta con bocca premente flangiata, posta in posizione radiale rivolta normalmente verso l'alto: flessibilità di installazione.

☑ Impeller closed type, dynamically balanced with thrust balancing chamber, and wear rings, easy replaceable for axial thrust compensation: reliability and simplify maintenance.

Roue du type fermé, équilibrée dynamiquement avec chambre d'équilibrage et anneaux d'étanchéité facilement remplaçables pour la compensation de la poussée axiale : fiabilité et simplifie la maintenance.

Girante del tipo chiuso, equilibrata dinamicamente, con camera di bilanciamento ed anelli di tenuta, facilmente sostituibile, per la compensazione della spinta assiale: affidabilità e facilità di manutenzione.

☑ Suction cover fastened to the casing by studs and nuts, with axial flanged suction inlet: simplify installation.

Couvercle d'aspiration fixé sur le corps de pompe au moyen de goujons et d'écrous et comportant la tubulure d'aspiration axiale à bride : simplifie la installation.

Coperchio aspirazione fissato sul corpo mediante prigionieri, con bocca di aspirazione assiale, flangiata: facilità di installazione.

☑ Bearing stand support, amply sized; serves as a base and support of the overhanged hydraulic part: sturdiness.

Palier largement dimensionné et faisant fonction d'appui pour la fixation de l'ensemble et sur lequel la partie hydraulique est montée en porte-à faux : résistance.

Supporto a sedia, ampiamente dimensionato; funge da base di appoggio e sostiene a sbalzo la parte idraulica: robustezza.

☑ Shaft guided and supported by two oil lubricated ball bearings housed in the bearing stand support. Bearings are amply sized for coupling to electric motors and endothermic engines by means of flexible coupling: ensure long life.

Arbre guidé et soutenu par deux roulements à billes logés dans le support et lubrifiés à l'huile. Ils sont largement dimensionnés pour permettre l'entraînement par moteur électrique ou thermique par l'intermédiaire d'un accouplement élastique : garantit une longue vie.

Albero guidato e sostenuto da due cuscinetti a sfere alloggiati nel supporto a sedia e lubrificati con olio; essi sono largamente dimensionati a permettere l'accoppiamento sia a motore elettrico che endotermico a mezzo di giunto elastico: garanzia di durata.

☑ Seal adjustable packing, easily replaceable: simplify maintenance.

Garniture à tresse facilement remplaçable : simplifie la maintenance.

Tenuta a baderna registrabile, facilmente sostituibile: facilità di manutenzione.

Engine driven pumping set - mobile installation
Groupe motopompe pour installation mobile
Gruppo motopompa per installazione mobile

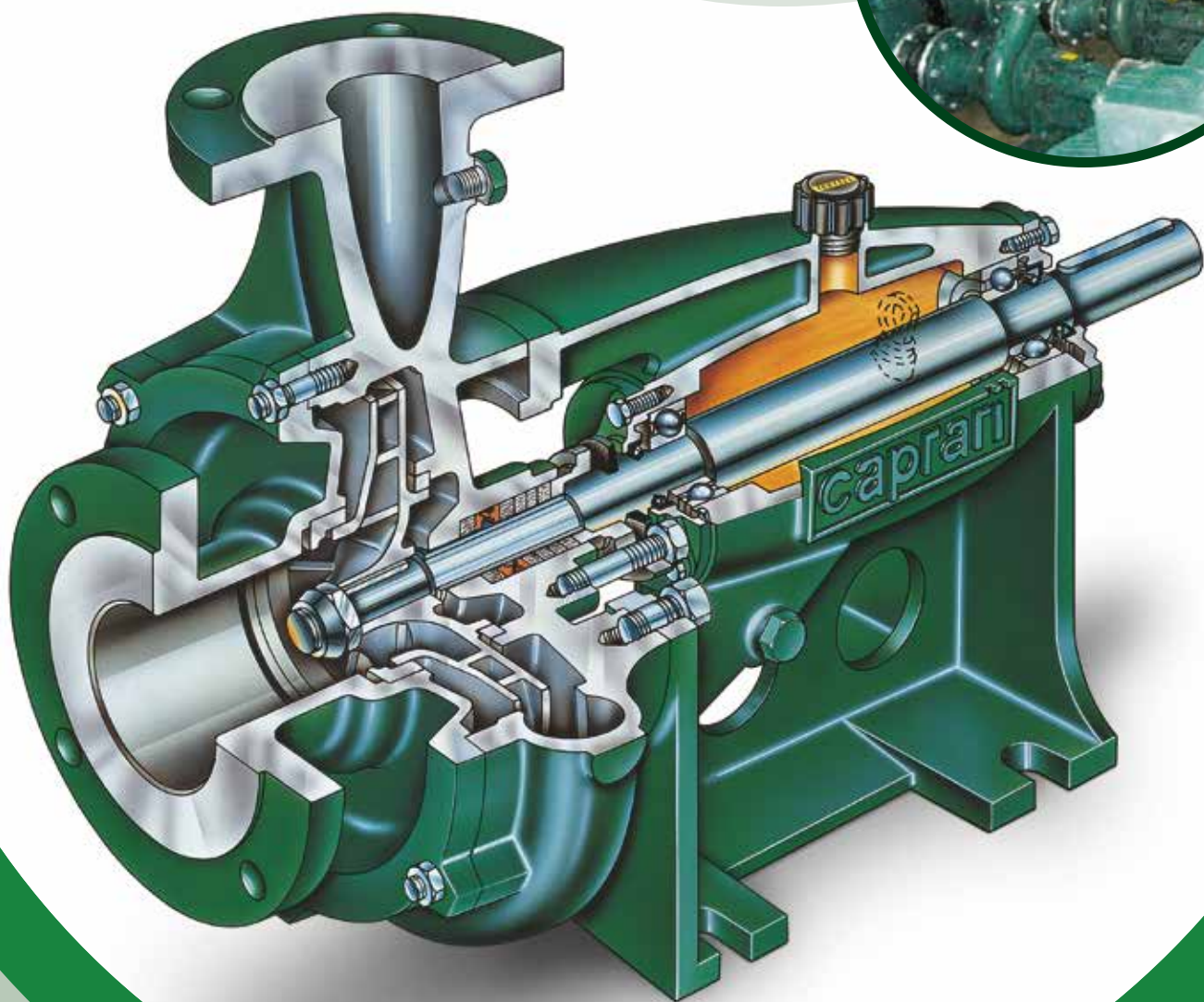

n=1450

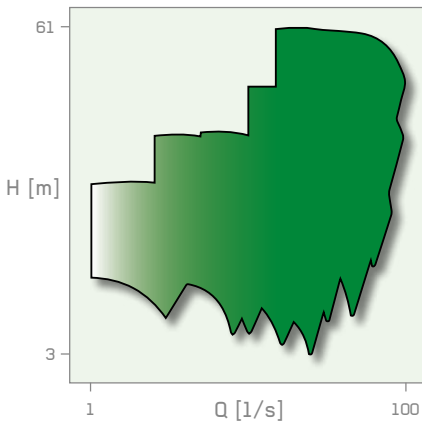

n=1750

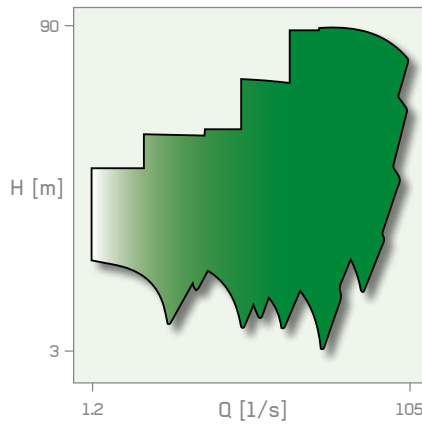

n=2000

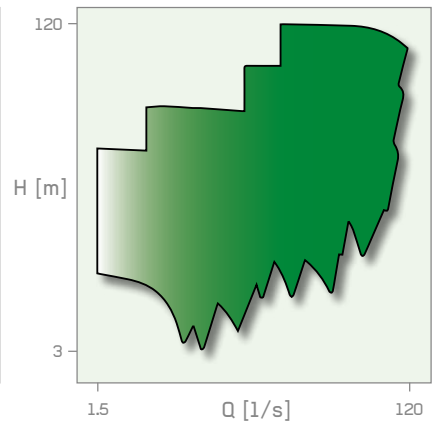

n=2200

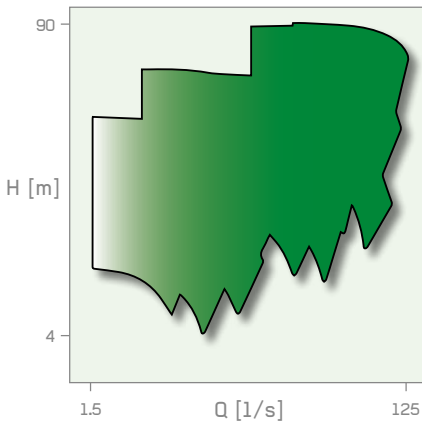

n=2400

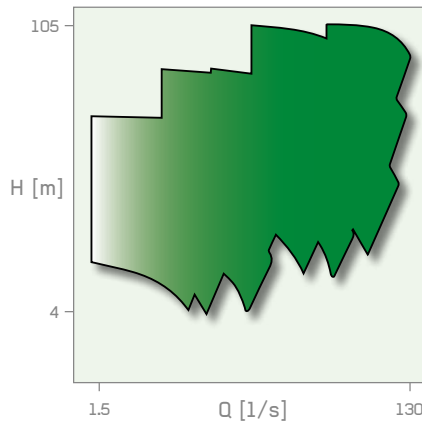

n=2650

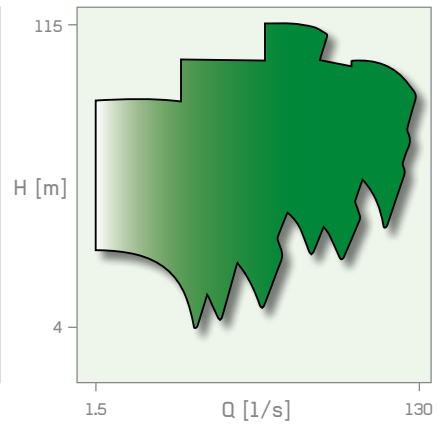

n=2900

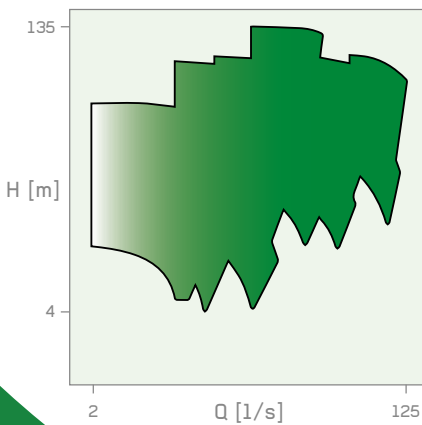

n=3500

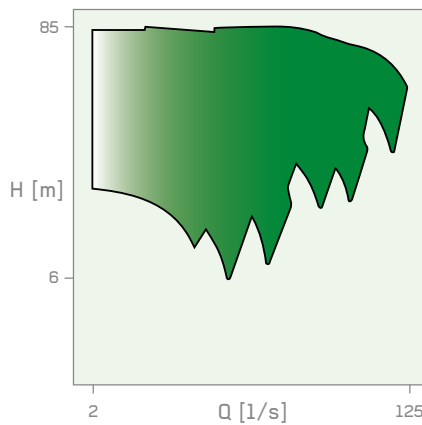

Special executions on demand
Exécutions spéciales sur demande
Esecuzioni speciali a richiesta

Mechanical seal
Garniture mécanique
Tenuta meccanica

Shaft in stainless steel
Arbre en acier inox
Albero in acciaio inossidabile

Bronze impeller
Roue en bronze
Girante in bronzo

Discharge size positioning
Orientation orifice de refoulement
Orientamento bocca

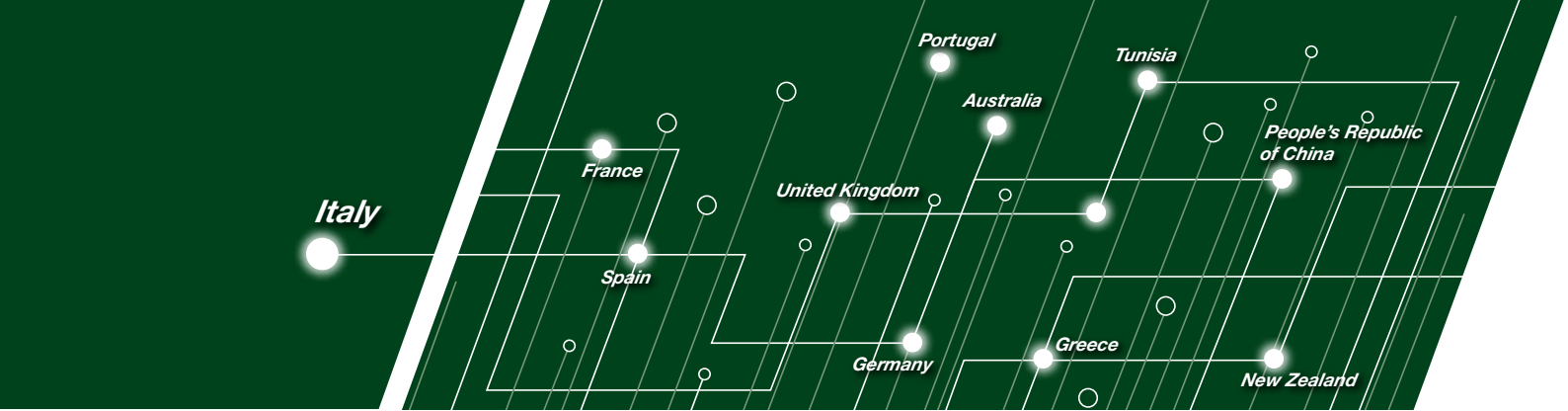

CAPRARI SPA Modena (Italy) • **CAPRARI FRANCE SARL** Maurepas - Paris (France) • **BOMBAS CAPRARI SA** Alcalà de Henares Madrid (Spain) • **CAPRARI PUMPS (U.K.) LTD** Peterborough (United Kingdom) • **CAPRARI PUMPEN GMBH** Fürth/Bayern (Germany) • **CAPRARI PORTUGAL LDA** Santarém (Portugal) • **CAPRARI PUMPS AUSTRALIA PTY LTD** Beverley SA (Australia) • **CAPRARI HELLAS SA** Thessaloniki (Greece) • **CAPRARI TUNISIE SA** Ben Arous (Tunisia) • **CAPRARI PUMPS (SHANGHAI) CO LTD** Shanghai (People's Republic of China) • **CAPRARI PUMPS NEW ZEALAND** Christchurch (New Zealand)



Water Collection and Distribution



Boosting and Distribution of surface water



Wastewater Transport and Treatment



Pump Control Technology

caprari
pumping power



www.caprari.com